



## Installation Instructions

### **D760-0056: COLD AIR INTAKE SYSTEM**

**Document Revision:** A  
**Release Date:** Aug 3, 2021

**Vehicle List:** 2020-2021 F95 X5M

### **Table of Contents**

Parts List .....	2
Tools Required .....	2
Removing the Stock Intake System .....	3
Scoop Panel Installation .....	5
Dinan Intake Assembly .....	6
Intake Boot Assembly .....	7
Enjoy .....	9

Thank you for being selective enough to choose a Dinan Performance Intake System. The Dinan engineering team has spent many hours developing this product to assure that you will receive increased performance, durability and an aesthetic design that you as a customer will be able to enjoy for many years. Ease of installation and maintenance is important to us and has been highly considered throughout the design process.

Prior to performing the installation, familiarize yourself with these instructions as it should help you with the process. If you feel that you do not have the required skills or tools, please arrange for a qualified repair facility to perform the installation.

If you have any difficulties during the installation or if these instructions are not clear to you, please call Dinan's Technical Support Staff at (800) 341-5480.

Again, thank you for choosing Dinan. Enjoy.

## Parts List

ITEM NO.	PartNo	DESCRIPTION	QTY.
1	#48Z	Clamp, 9mm, 80-100	1
2	#64Z	Clamp, 9mm, 90-110	5
3	D401-0030	Air Filter	2
4	D671-0147	M4 x 10 x 0.7P Button Head, SS	8
5	D671-0245	Washer, Metal-Bonded Sealing, .180 ID x .375 OD	8
6	D671-0246	Washer, Rubber, 0.195 ID X 0.438 OD, BLK	10
7	D712-0034	Badge, Dinan Emboss AL, Adhesive Back	1
8	D762-0265	Main Snorkel	1
9	D762-0266	Main Rubber Boot	1
10	D762-0267	Bellow, 4x2.5x0.8, EPDM 60A, BLK	1
11	D762-0268	Bellow, 4.0-3.625x2.5x0.8, EPDM 60A, BLK	1
12	D763-0171	Assy, Front Inlet	1
13	D763-0172	Assy, Left Airbox	1
14	D763-0173	Assy, Right Airbox	1
15	D763-0096	Gasket, Trim, U-Channel	2

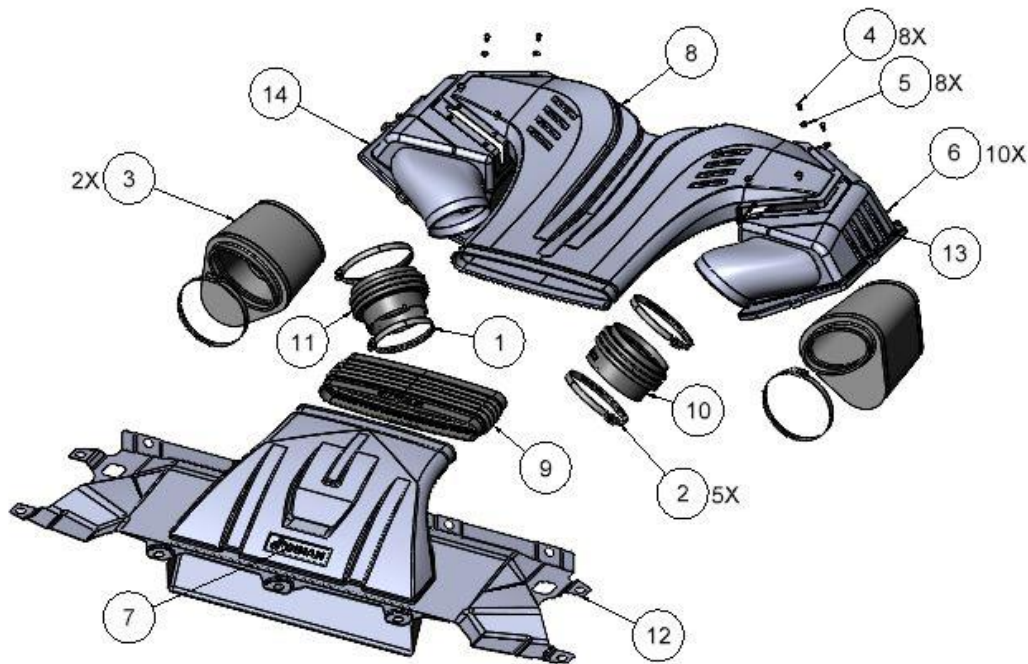

**\*\*D502121- Tie Strap not shown\*\***

## Tools Required

- Cutting Shear and/or Rotary Cutting Tool
- 8mm Socket
- 13mm Socket
- 2.5mm Hex Key
- Flat Head Screw Driver
- T25 Torx Bit
- T30 Torx Bit
- T40 Torx Bit

## Removing the Stock Intake System

1. Remove the Engine Cover.



2. Remove all the push rivets and bolts holding the plastic cover, as shown. Repeat on other side as well. The sealing gasket shall be unclipped on both sides as shown below in order to properly raise the plastic cover. This operation will allow access to bolts needed in upcoming steps.

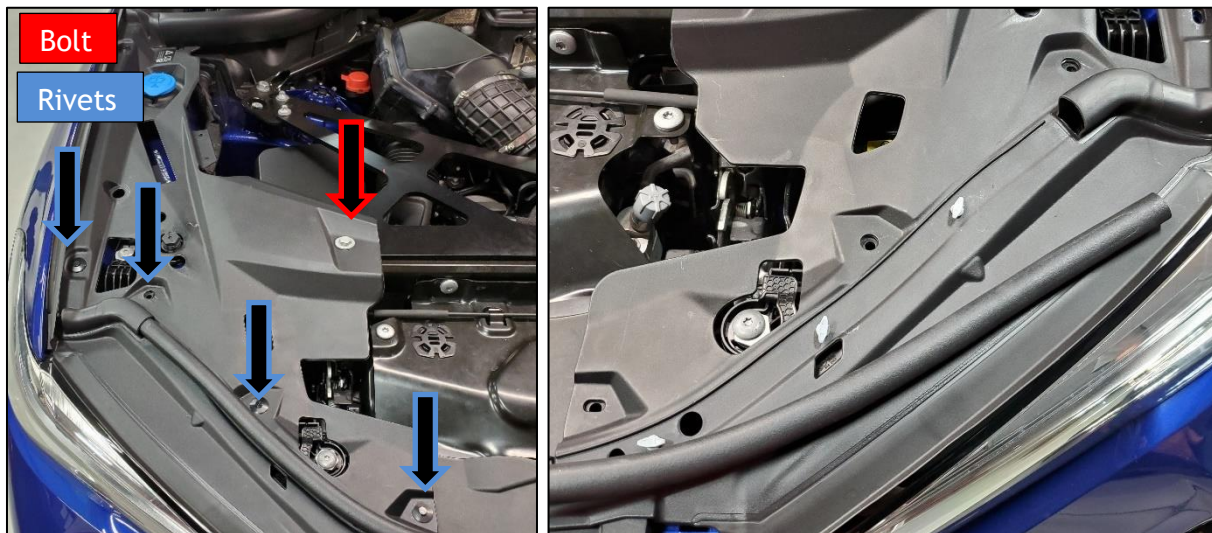

- Remove the 12 bolts as shown below and unclip the hood latch cable from the panel. Also remove the 4 bolts holding down the front plastic panel. This will help installation of the Dinan front scoop. Remove the panel. Once out of the vehicle, remove the radiator vibration mounts. Both the bolts and radiator mounts will be re-used during the Dinan install.

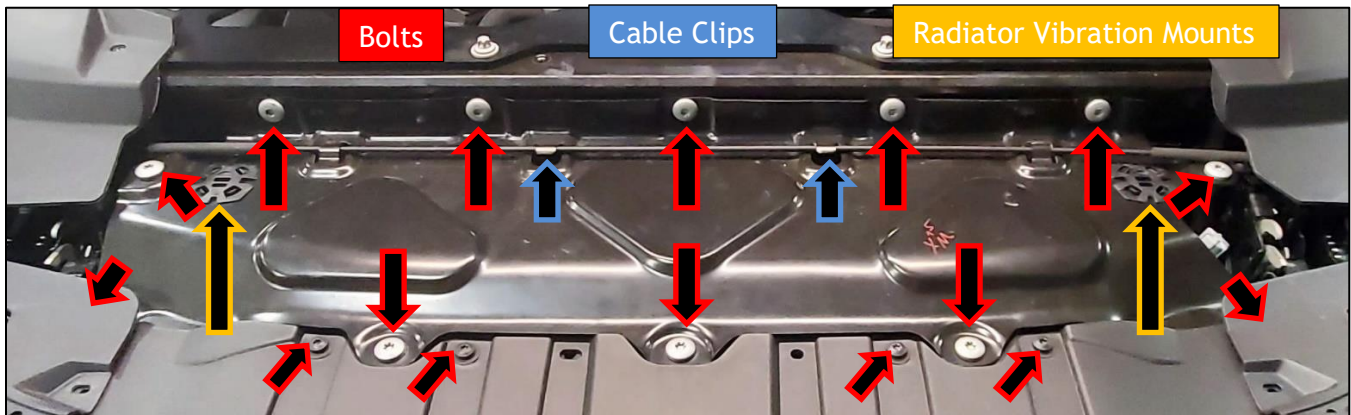

- Once this metal plate is removed, you will have access to the air duct radiator cap. This cap will need to be modified to accept the Dinan Front Inlet.

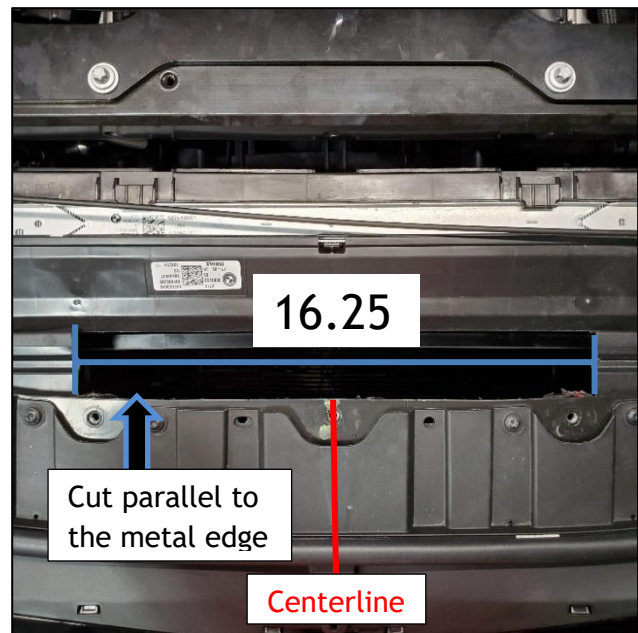

- Tools needed will be cutting shears and/or a rotary cutting tool with a cutting wheel attachment. As shown above, the width shall be marked at 16.25", about the centerline of the vehicle (8.125" on each side). Using the cutting shears, cut parallel to the centerline at the marked dimensions.
- The front lip of the of the air duct radiator cap should be cut with a cutting wheel to achieve the best results. Make sure that the material removed is flush with the metal lip when looking from top down. This will allow the front inlet to fit down into the grill air duct.
- Clean up edges if necessary and discard the cutout piece.

5. Remove both airbox lids and outlet tubes as shown below. There are 6 screws and 2 hose-clamps for each airbox. These screws will be re-used. It is also recommended to remove the lower intake box, although not necessary. This removal may help the install of Dinan components as well as re-install to the vehicle.

**WARNING** – The turbocharger inlet is now exposed. Items that fall inside can cause severe damage to the turbo! Be sure to place a rag or towel in the inlet to protect the turbo.



## Front Inlet Installation

- 1) Zip tie the hood latch cable to the slot opening on the air duct radiator cap before installing Front Inlet. Cut off tail and ensure the cable is seated behind the mounting post on both sides, as shown below.

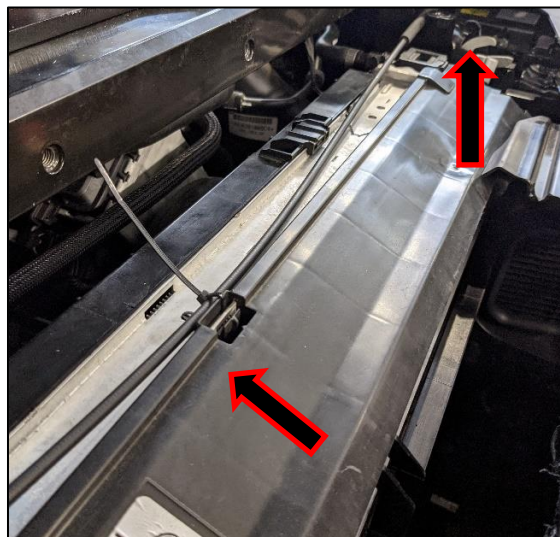

- 2) With the air duct radiator cap properly cut out, the front inlet should slide into the opening.
- 3) Re-install the radiator vibration mounts on either side.
- 4) Reinstall the stock bolts into the Dinan front inlet. There will be an extra bolt because the Dinan inlet obstructs the vertical center bolt hole. Reinstall the 4 bolts for plastic panel.

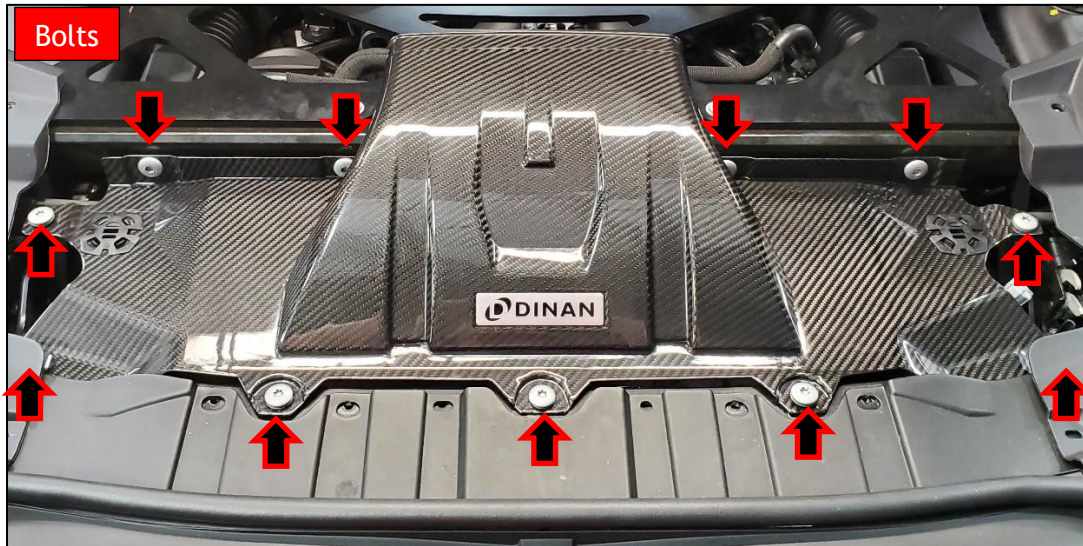

## Dinan Intake Assembly

- 1) Install the rubber trim gasket included in the hardware kit onto each lower intake box. This gasket will need to be trimmed after installation. To make for easier installation, start the gasket on a right-angle corner as shown below.



- 2) Install the filter into the Dinan intake lid, ensuring proper orientation as shown below. Tighten the 90-110mm clamp.

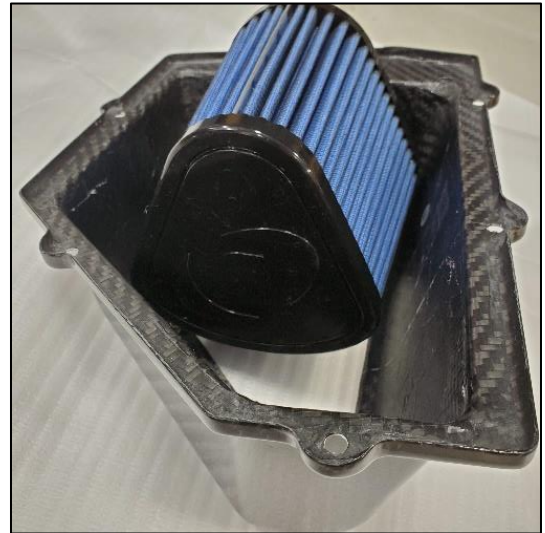
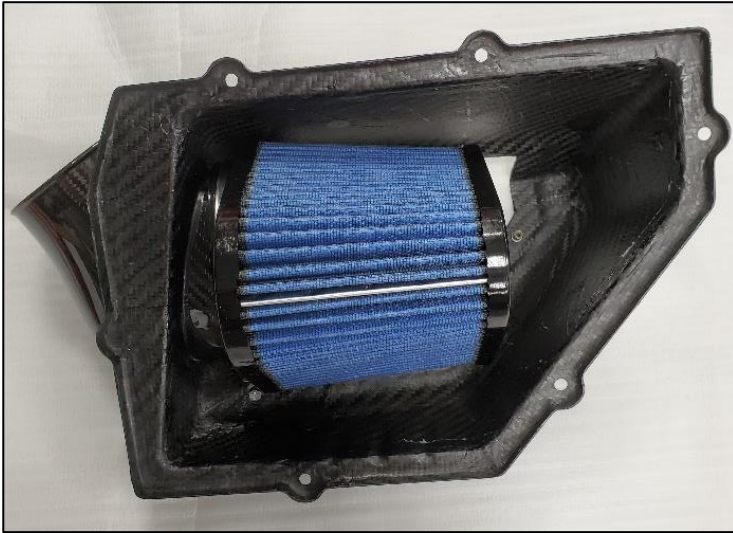

### Intake Bellow Assembly

- 1) Refer to the parts diagram and install the intake bellows to the airboxes. The smaller diameter bellow will be positioned on the passenger side facing towards the turbo intake tube. Position the 90-110 clamp heads toward the center of the vehicle as this will look the best once fully installed. Each boot has a slot that should be positioned such that it aligns with the slot on the stock intake tubes to the turbo.



- 2) You can now install the two upper airboxes to the lower box and place into the engine bay. To prevent the carbon from scratching, slide the rubber washers onto the stock airbox screws prior to attaching the Dinan airbox lids to the lower boxes.
- 3) Each boot has a slot that should be positioned such that it aligns with the slot on the stock intake tubes that feed to the turbo. Use the smaller 80-100 clamp for the passenger side and the larger 90-110 clamp for the driver side connections.



- 4) You can now install the Dinan Main Snorkel. Before installing, seat the main rubber boot onto the bottom of the snorkel.



- 5) To install the main snorkel, slide the boot over the scoop. Make sure the boot fully surrounds the front inlet and snorkel. Check the underside fitment as an improper seal will affect performance.



- 6) Bolt the snorkel to the upper boxes with the 8 provided M4 screws and metal bonded washers. Once it is attached, the engine bay should look like the one pictured below.

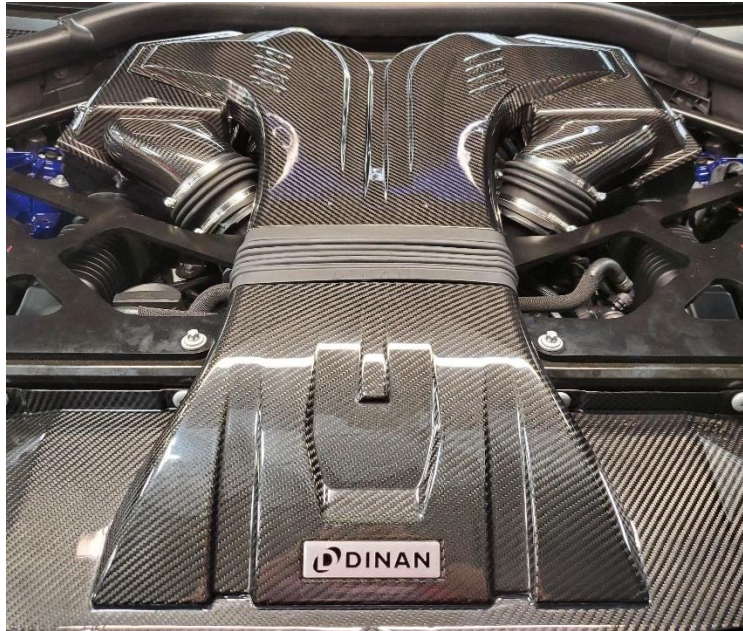

## Enjoy

Installation is now complete. Clean the carbon fiber with a microfiber cloth and ensure all tools are removed from engine compartment prior to closing the hood.